

HEALTHCARE DIVISION BY

**KEWAUNEE**  
EST 1906



**EVERHUTCH**

**STORAGE  
WITH  
PURPOSE**

# THE NEWEST AND LARGEST HEALTHCARE STORAGE



HEALTHCARE DIVISION BY  
 KEWAUNEE

At EVERHUTCH we make vital products for the healthcare space. We provide you with STORAGE WITH PURPOSE that you need to organize and optimize your environment with our procedure carts and cabinets.

EVERHUTCH leverages more than a century of experience from Kewaunee, a recognized global leader in the design, manufacture, and installation of laboratory, healthcare, and technical furniture products.

A North Carolina-based company founded in 1906, KEWAUNEE'S history of quality products and scientific expertise empowers EVERHUTCH to provide you with healthcare solutions to deliver quality patient care. With a suite of products designed to meet the needs of both the modern healthcare setting and clinical lab space, flexibility and adjustability are essential.

Our long-standing history of working with architects and planners means no project is too small or large. Our manufacturing capabilities are unrivaled in healthcare, from individual carts to capital projects for new construction hospitals. We can provide any or all products by leveraging our own local warehousing ensuring on-time delivery for your project.

We've got you from start to finish. Our products are proudly made in the United States under one roof, ensuring quality and reliability throughout the entire process.





# STAT CART

**PROCEDURE CART**

# CORE CART & CABINET

**PROCEDURE CABINET**



# CORE BENCH

**PROCEDURE BACKTABLE**

# NEST CART

**UTILITY CART**



# STAT CART

WIDTH  
HEIGHT  
COLOR  
DRAWER CONFIG  
TRAY CONFIG  
LOCK OPTIONS  
ACCESSORIES

**YOUR CART**



This procedure cart was specifically designed for patients and caregivers in mind. Defining features promote infection control, adaptability and durability. STATCART standard sizes and options in drawers and trays were made to be compatible with existing procedure carts on the market today. This compatibility creates conformity and allows hospitals to easily upgrade their cart without the need to update protocols. STATCART is quickly adaptable to meet the demands of different departments with an efficient Equipment Management Rail System. With just a click you can configure your cart on this double-sided rail system. Due to the adaptability of its components, this system allows customers to find the optimal solution to answer specific clinical needs. Available with multiple lock options including a keyed lock, electronic keypad and electronic keypad with proximity card reader.

The cart is easily maneuvered around on plate-mounted swivel and locking casters. This high quality storage system is manufactured and sourced in the US and can withstand any demanding healthcare environment.

# STAT CART | SPECIFICATION

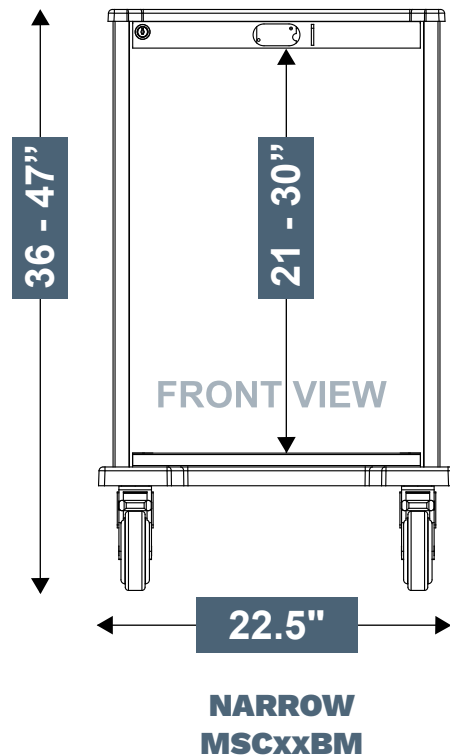
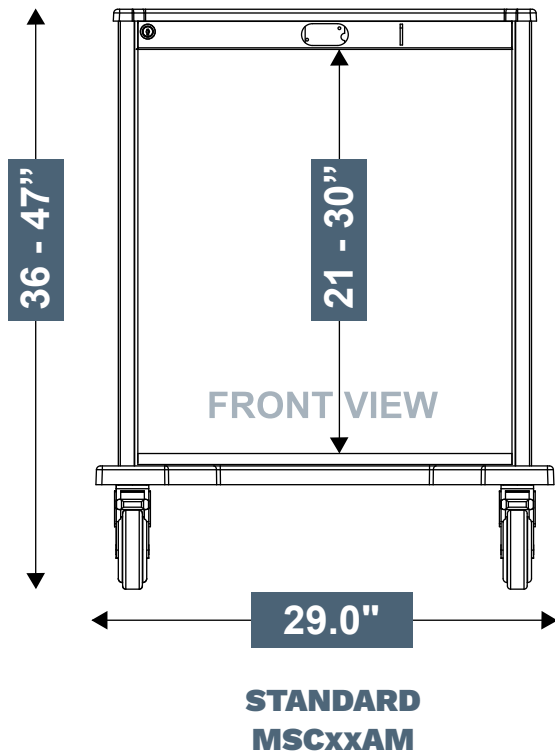

## SPECIFICATIONS

### Maneuvers Easily

- Heavy-duty construction
- 5" locking swivel casters
- 5" tracking caster

### Supports Thorough Cleaning

- Integrated seams
- Smooth exposed surfaces
- Chemical resistant powder coat
- Corner posts with less channels to clean
- Removable draws & trays
- Scratch resistant work surface with drip edge
- & smooth corners for easy cleaning

## SPECIFICATIONS

### Caster

- 5" Swivel Locking Casters:
- 3 Total Lock & 1 Direction Lock
- 3.875" Caster Overall

### Material

- Shell 18-Gauge Steel
- Drawers 20-Gauge Steel

### Security

- Key lock
- Electronic keypad
- Prox card reader (High and Low frequency's)
- Self-closing drawers

### Adaptable To Your Workflow

- Configurable drawers of increments of 3" – 6" and 9"
- Full-extension, soft closing drawers
- Interchangeable components with Paladin Health-care Equipment Management Rail System
- 8 STATCART configurations available in 2 widths and four heights.

### Finish

- ABC Powder Coat

### Drawer handles

- Brushed Stainless Steel

### Warranty

- Limited Life Time Warranty

# STAT CART | LOCK OPTIONS

CONFIGURE YOUR CART SECURITY  
WITH THESE LOCK OPTIONS



## 01 MANUAL LOCK

Comes as Standard



## 05 ELECTRONIC LOCK

- 250 user/supervisor codes
- Flush-mounted membrane keypad with Battery pack
- Standard RJ11 communications port for audit trail download
- Audit trail of last 1500 access attempts with date, time and user name
- Motor driven latching mechanism



## 06 KEYLESS ELECTRONIC KEYPAD

PROXIMITY CARD HID ACCESS

## 07 KEYLESS ELECTRONIC KEYPAD

I-CLASS HID ACCESS HIGH FREQUENCY

## 08 BREAKAWAY



## 09 GANG LOCK



## 10 2-GANG LOCK



# STAT CART | HEIGHT

## STANDARD WIDTH 29"



**36" H**  
MSC21AM



**40" H**  
MSC24AM



**44" H**  
MSC27AM



**47" H**  
MSC30AM

## NARROW WIDTH 22.5"



**36" H**  
MSC21BM



**40" H**  
MSC24BM



**44" H**  
MSC27BM



**47" H**  
MSC30BM

## COLOR COMBINATIONS



- Powder coat finishes
- Drawer faces can be colored separately from cart shell
- Other colors upon request

## POWDER COAT FINISHES Additional colors on feature page



# STAT CART | DRAWER CONFIGURATIONS



Each cart height offers several drawer combinations comprised of these drawer heights:

- 3"
- 6"
- 9"

**\*EXAMPLE BELOW SHOWING 30" STAT CART DRAWER COMBINATIONS**

MSC30AM050



MSC30AM131



MSC30AM212



MSC30AM240



MSC30AM321



MSC30AM430



MSC30AM511



MSC30AM810



## PART NUMBER

**MSC 21 AM XXX - 01 HT1**

Heights

Widths

Drawer Config  
3" - 6" - 9"

Lock  
Config

Tray  
Kits

24 BM  
27  
30

05  
06  
07  
08  
09  
10

T1  
T2

PN Example: MSC30AM321-01HT1

# STAT CART | TRAY OPTIONS

## SINGLE TRAY OPTION - T1



## SPLIT TRAY OPTION - T2



**MSC500A3TRKT1**  
3" D  
Full Single Tray



**MSC500A6TRKT1**  
6" D  
Full Single Tray



**MSC500A3TRKT2**  
3" D  
Split Tray



**MSC500A6TRKT2**  
6" D  
Split Tray



**MSC500A9TRKT1**  
9" D  
Full Single Tray

## NARROW TRAY OPTION - T3

For BM Narrow Carts only



**MSC500B3TRKT3**  
3" D  
Narrow Tray



**MSC500B6TRKT3**  
6" D  
Narrow Tray

# STAT CART | CONFIGURATIONS

## CODE CART



**PN: MSC30AM321-10HT1-COD**

**MSC667-IN** - Standard ACC Shelf Installed

**MSC633-IN** - Flip-Up 20" Writing Surface Installed

**MSC657-IN** - Universal Side Rail (right) Installed

**MSC619-IN** - CPR Board Kit Installed

**MSC664-IN** - Rear Goal Posts Installed

**MSC620-IN** - IV Pole Installed

**MSC674-IN** - O2 Holder Installed

**MSC635-IN** - Suction Pump Shelf Installed

**MSC691-IN** - Defibrillator Shelf Installed

**MSC676-IN** - Sharps Box Mount Installed

**-10 Two Gang Lock**

## IV START CART



**PN: MSC24AM230-01HT1-IVS**

**MSC644-IN** - 4-Tilt Bin Installed

**MSC620-IN** - IV Pole Installed

**MSC622-IN** - Triple Glove Box Installed

**MSC664-IN** - Rear Goal Posts Installed

**MSC676-IN** - Sharps Box Mount Installed

**-01 Key Lock**

# ANESTHESIA CART



**PN: MSC27AM411-05HT1-ANE**

**MSC676-IN** - Sharps Box Mount Installed

**MSC628-IN** - Waste Bin Kit Installed

**MSC665-IN** - Rear Goal Posts Ext. Installed

**MSC644-IN** - 4-Tilt Bin Installed

**MSC645-IN** - 5-Tilt Bin Installed

**MSC620-IN** - IV Pole Installed

**MSC633-IN** - Flip-Up 20" Writing Surface Installed

**MSC622-IN** - Triple Glove Box, Installed

**MSC657-IN** - Universal Side Rail

**-05 Electronic Lock**

# ISOLATION CART



**PN: MSC24AM311-01HT1-ISO**

**PN: MSC24BM311-01HT3-ISO**

**MSC622-IN** - Triple Glove Box Installed

**MSC628-IN** - Waste Bin Kit Installed

**MSC690-IN** - Sani Wipe Mounting Kit, Installed

**-01 Key Lock**

# STAT CART | CONFIGURATIONS

## CAST CART



### PN: MSC27AM221-01HT1-CAS

**MSC667-IN** - (2x) Standard ACCY Shelf Installed

**MSC628-IN** - Waste Bin Kit Installed

**MSC665-IN** - Rear Goal Posts Ext. Installed

**-01 Key Lock**

## DIFFICULT AIRWAY



### PN: MSC27AM411-01HT1-DIF

**MSC628-IN** - Waste Bin Kit Installed

**MSC665-IN** - Rear Goal Posts Ext. Installed

**MSC644-IN** - 4-Tilt Bin Installed

**MSC674-IN** - O2 Tank Holder Installed

**MSC667-IN** - Standard Accessory Shelf, Installed

**-01 Key Lock**

# PEDIATRIC CART



## PN: MSC30AM810-08HT1-PED

**MSC674-IN** - O2 Tank Holder Installed  
**MSC691-IN** - Defibrillator Shelf Installed  
**MSC635-IN** - Suction Pump Shelf Installed

**MSC620-IN** - IV Pole Installed  
**MSC619-IN** - CPR Board Kit  
**-08 Breakaway Lock**

# SUTURE CART



## PN: MSC27AM330-01HT1-SUT

**MSC676-IN** - Sharps Box Mount Installed  
**MSC628-IN** - Waste Bin Kit Installed  
**MSC665-IN** - Rear Goal Posts Ext. Installed

**MSC687-IN** - (2x) 24"L Suture Shelf Installed  
**MSC633-IN** - Flip-Up 20" Writing Surface Installed  
**-01 Key Lock**



# STAT CART

WIDTH  
HEIGHT  
COLOR  
DRAWER CONFIG  
TRAY CONFIG  
LOCK OPTIONS  
ACCESSORIES

## YOUR CART

**ABS Acrylic, Scratch Resistant, Easy-to-clean Top with Spill Edge; UV Protection to Prevent Yellowing**

**Multiple Configurations for Top Accessories**

**Easily Accessible Battery & Lock Upgrades**

**Keyed, RFID, & Electronic Gang Locks**

**Stable & Ergonomic Grab Handles**

**Sturdy Side Rails Have Minimal Areas to Harbor Bacteria**

**Multiple Depths of Drawers with Split and Single Trays**

**Drawers Accept Most Common Tray Inserts. STATCART Drawer Sizes: Standard: 22.5"W x 17.75"D Narrow: 17"W x 17.75"D**

**Sturdy, Easy-to-clean, Locking Casters**

**Sanitary & Strong Lower Bumpers**

**Toolless Accessory Changes Using the Fairfield Rail System**

## 2X WIDTHS — 4X HEIGHTS



## DRAWER COMBINATIONS

Comprised of these drawer heights:

- 3"
- 6"
- 9"



Example above shows (2) 30"H STATCART drawer combinations

## COLOR COMBINATIONS

Drawer faces can be colored separately from cart shell



See color combination examples below

## CONFIGURE YOUR CART



## PRODUCT VIDEO

SCAN  
HERE



# STAT | EQUIPMENT CART | MANAGEMENT

The EVERHUTCH equipment management system provides flexibility and the opportunity to configure any cart to work in any department. Accessories can be easily removed, added or relocated to another position on the cart to increase efficiency and ergonomics. These accessories can also be moved easily from existing wall equipment rail systems to the cart and back again. This system gives healthcare workers the flexibility needed for optimum patient care.

## FROM WALL TO CART



# STAT CART | ACCESSORIES

## TILT BINS - GREY PLASTIC BOX WITH CLEAR PLASTIC BINS



**MSC643**

9.25 x 23.625 x 6.25" HWD  
3-Bin



**MSC644**

8.125 x 23.625 x 5.375" HWD  
4-Bin



**MSC645**

6.5 x 23.625 x 4.25" HWD  
5-Bin



**MSC673**

4.5 x 23.625 x 3.625" HWD  
6-Bin

## BASKETS - POWDER COATED METAL



**MSC646**

4.25 x 10 x 7" HWD  
Small Basket



**MSC647**

4 x 18 x 10" HWD  
Large Basket



**MSC648**

4.75 x 5.375" HD  
Small Basket

## HOOKS - WITH AN INTEGRATED MOUNTING PLATE



**MSC679**

2.5 x 1.5 x 2" HWD  
1-Hook 2"



**MSC680**

2.5 x 1.5 x 4" HWD  
1-Hook 4"



**MSC681**

2.5 x 12 x 2" HWD  
2-Hook 2"



**MSC682**

2.5 x 12 x 4" HWD  
2-Hook 4"

# STAT CART | ACCESSORIES

## MONITOR MOUNTING AND CABLE MANAGEMENT



**MSC634**  
6 x 4 x 8.5" HWD  
GCX-Style Swing Arm  
(GCX Not Included)



**MSC637**  
27 x 4 x 21.5" HWD  
Mounting Arm Only  
(Monitor Not Included)

**MSC671**  
27 x 11 x 32" HWD  
Arm & Laptop Holder



**MSC684**  
7.75 x 1.5 x 1.5" HWD  
Cord Cleat



**MSC672**  
3.5 x 1.5 x 0.75" HWD  
Cord Bundler

## WASTE MANAGEMENT



**MSC628**  
3 x 21 x 1" HWD  
12qt Waste Bin Rail Mount Kit  
(Trash Can Included)



**MSC676**  
3 x 21 x 1" HWD  
Locking Mount For  
Daniels Sharps Box  
(Sharps Box Included)



**MSC675**  
3 x 21 x 1" HWD  
Non-Locking Mount For  
Universal Sharps Box  
(Sharps Box Not Included)

\*KENDALL, COVIDIEN  
& BEMIS SHARPS

# STAT CART | ACCESSORIES

## SHELVES - FIXED AND FOLDING



**MSC632**  
15 x 10" WD  
15" Flip-Up Surface  
Side-Mounted

Scratch resistant food-grade high-density polyethylene.  
Indented spill lip. Up to 100lb load capacity.



**MSC633**  
24 x 18" WD  
24" Flip-Up Surface  
Rear-Mounted

Scratch resistant food-grade high-density polyethylene.  
Indented spill lip. Up to 100lb load capacity.



**MSC630**  
3 x 11 x 9.5" HWD  
10" Fixed Writing Surface  
With Lip Edges



**MSC631**  
3 x 11 x 14" HWD  
14" Fixed Writing Surface  
With Lip Edges



**MSC668** - 8.5" D  
**MSC668D** - 11" D  
5.125 x 18.2" HW  
Narrow Width Accessories Shelf



**MSC667** - 8.5" D  
**MSC667D** - 11" D  
5.125 x 23.7" HW  
Standard Width Accessories Shelf

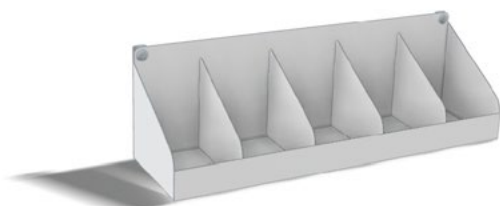

**SUTURE SHELF**  
**MSC687** - Standard 24" L  
**MSC688** - Slim 18" L  
**MSC689** - Side-Mounted 20" L

# STAT CART | ACCESSORIES

## RAILS



**MSC657**  
21.5" L  
Universal Side Rail



**MSC658**  
23.5" L  
Rear Rail  
Standard Width



**MSC659**  
18" L  
Rear Rail  
Narrow Width



**MSC619**  
23 x 18 x 1" HWD  
CPR Board & Bracket



**MSC655**  
23.5" W  
Rear Accessory Rail Kit  
Standard Width



**MSC656**  
18" L  
Rear Accessory Rail Kit  
Narrow Width



**MSC670**  
19 x 9.125 x 4.7" HWD  
Catheter Storage Box



**MSC664**  
24" H  
Rear Accessory Overbridge  
Standard Height



**MSC665**  
38" H  
Rear Accessory Overbridge  
Extended Height

# STAT CART

# ACCESSORIES

## MISCELLANEOUS ACCESSORIES

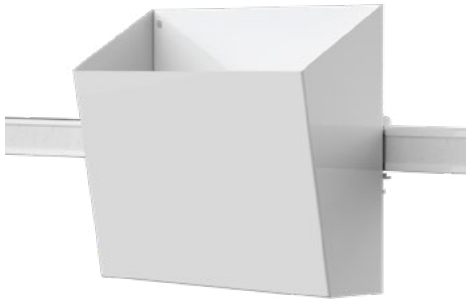

**MSC636**  
7.75 x 9.625 x 3.75" HWD  
Chart Holder



**MSC683**  
9 x 2.5 x 1.75" HWD  
4-Outlet Power Strip



**MSC691**  
19 x 14.7 x 14.7" HWD  
Defibrillator Shelf



**MSC606**  
0.75 x 26.8 x 23" HWD  
Standard Top



**MSC686**  
3.2 x 12.5 x 5" HWD  
Anes Label Holder



**MSC690**  
Caviwipes Bracket

**MSC607**

0.75 x 21.8 x 23" HWD  
Narrow Top

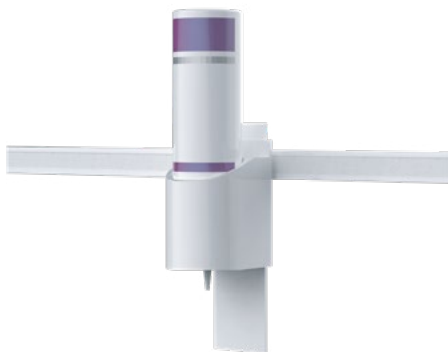

**MSC639**  
7 x 2.5 x 1" HWD  
Foam Dispenser & Bracket



**MSC663**  
2.5 x 1.5 x 0.75" HWD  
Rail Bracket



**MSC618**  
3 x 22.25 x 3" HWD  
Side Handle

# STAT CART | ACCESSORIES

## GLOVE BOX HOLDER - POWDER COATED METAL



**MSC622**  
**16.75 x 9.5 x 4.5" HWD**  
**Triple Glove Box**  
(Vertical Mount)

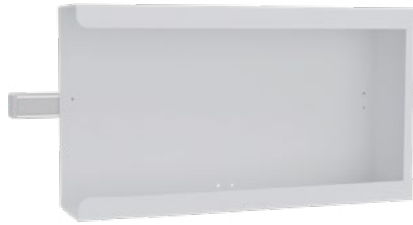

**MSC625**  
**9.5 x 16.75 x 4.5" HWD**  
**Triple Glove Box**  
(Horizontal Mount)

## MEDICAL GAS



**MSC674**  
**16 x 5.5 x 5.5" HWD**  
**Oxygen Holder**



**MSC635**  
**10.125 x 20.9 x 8.5" HWD**  
**Suction Pump Shelf Kit**  
(Pump Not Included)

## LOCK UPGRADES

**MSC660** - Electronic Lock Upgrade

**MSC661** - Electronic Proximity Lock Upgrade

**MSC662** - Electronic Proximity Lock Upgrade Iclass HID Access

# STAT CART | ACCESSORIES

## INFUSION MANAGEMENT



**MSC620**  
**12" POLE x 2" D**  
**IV Pole**  
(Adjustable Height)



**MSC624**  
**4 x 1" (HD) ON 5' AMF POST**  
**C-Clamp Pole Mount**



STATESVILLE, NC

**EVERHUTCH.COM** - STORAGE WITH PURPOSE



# CORE CART

The cell storage system was specifically designed for use in the healthcare industry. This high-quality logistic system is ISO 3394 standardized and can be used in all departments of the hospital. Because of the adaptability of its components, this system allows customers to find the optimal solution that answers to their specific needs while saving up to 30% of space in comparison to more traditional shelving systems.

Available with multiple lock options, including keyed lock, electronic keypad, and electronic keypad with proximity card reader (two frequencies).

The cart is on four swivel locking casters for ease of movement and designed in a powder coated steel for efficient cleaning, and includes two side handles for easy maneuverability.

- Available heights 76"
- Key lock options
- Tempered glass doors



# CORE CART

PRODUCT VIDEO

SCAN  
HERE



Sloped Tops



Catheter Racks



20ga Cold-rolled Steel Construction



Multi-angle Trays, Shelves, & Brackets



Keyed & Electronic Locks

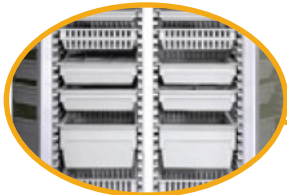

Multiple Heights of Trays & Baskets



Push Handles



Easy-to-clean, Locking Casters



Interior Dividers Allow for Multiple Storage Configurations



## PART NUMBER

**MCT** \_\_\_\_\_ **G2N**  
 Bay      Divider      Lock Option      Package Option

PN Example: MCT302-XX-G3C

- Height: 78.75" x Depth: 27"
- Caster Wheel 5"
- Conforms to UL 60601
- Shell 18 Gauge steel, double-sided construction

# CORE CART

# SPECIFICATION

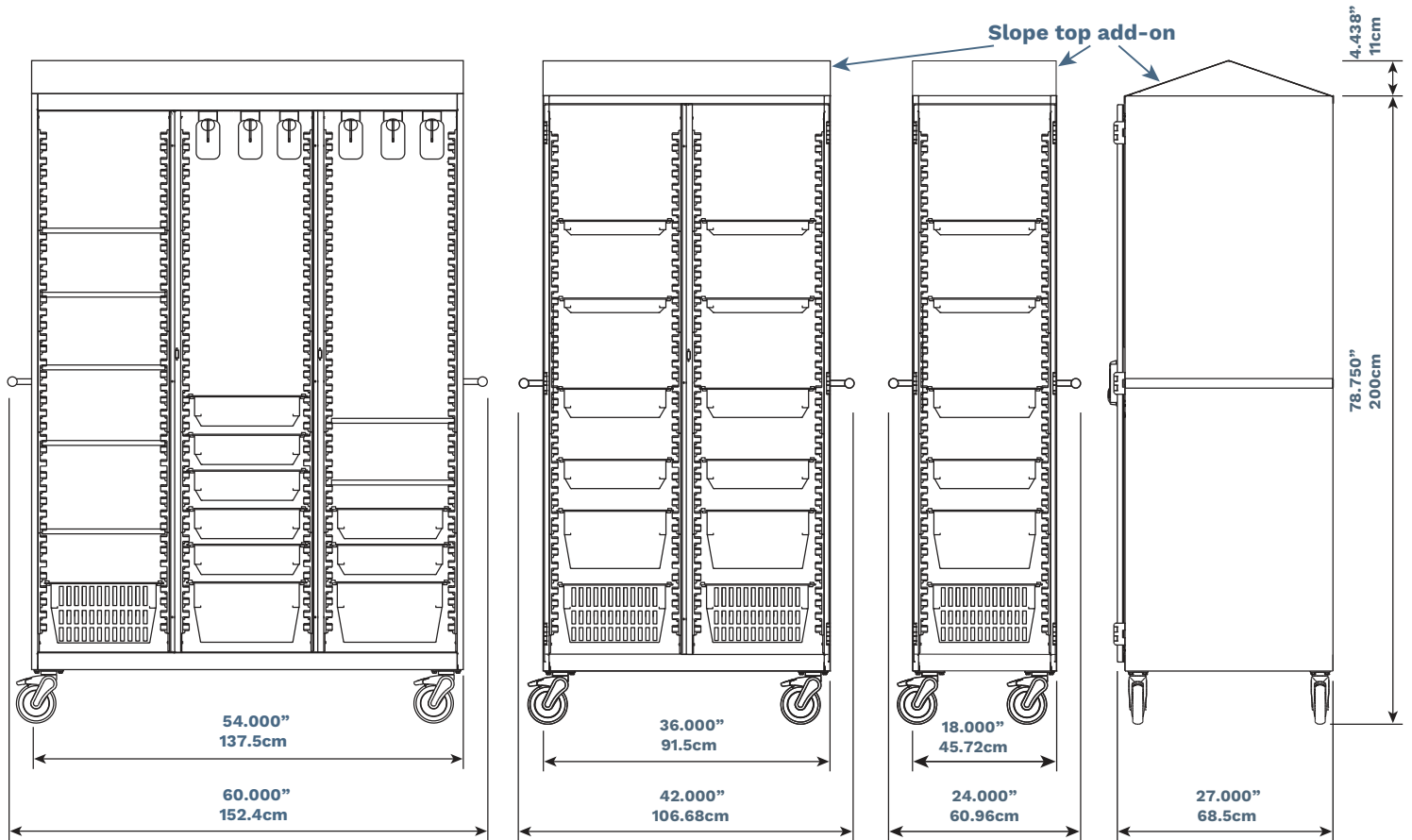

## KEY FEATURES

### Maneuvers easily

- Customized solutions for Cath labs, IR labs, OR, Endo/ bronch and General Storage.
- Robust design
- Conforms to UL 60601
- 5" Locking swivel casters

### Customizable

- 21 Accessory packages available
- 29 Individual accessories available

### Adaptable to Your Workflow

- Adaptable as needs change with various accessory packages
- Interchangeable components with EVERHUTCH solutions
- Accommodates variety of medical equipment
- Configure your own custom CORE Cart

## SPECIFICATIONS

- Dimensions: 78.75 x 36 x 27" HWD
- Weight: 275 LB (2 Bay)
- Caster Wheel 5"

### Certifications

- Conforms to UL 60601

### Finish

- Snow White Powder Coat

### Door Handles

- Brushed Stainless Steel

### Side Handles

- Brushed Aluminum

### Warranty

- Refer to EVERHUTCH.com for complete warranty information

# CORE CART PROCEDURE CART

**3-BAY**

**2-BAY**

**1-BAY**



# CORE CART

## MAXIMIZE STORAGE



**CHOOSE YOUR  
HANDLE OPTIONS**



**WITH HANDLES 42"**

$$42" \times 5 = 210"$$



**NO HANDLES 36"**

$$36" \times 5 = 180"$$

**30" SPACE SAVING**  
5 x 2-Bay CORE CARTS

# CORE CABINET



## PART NUMBER

### MCC

Bay Configuration

Door Opening

Lock Option

**100** = 1-Bay

**200** = 2-Bay, No Div

**201** = 2-Bay, Ctr Div

**202** = 2-Bay, Split Div

**300** = 3-Bay, 2 Div

**301** = 3-Bay, LH Div

**302** = 3-Bay, RH Div

**L** = Left Door

**R** = Right Door

**0** = No Lock

**1** = Key Lock

**2** = Key Pad

**3** = Prox Low Frequency

**4** = Prox High Frequency

**PN Example: MCC100-R0**

**1-Bay CORE CABINET, Right-hand Door, No Lock**

\*Accessories not included



## 4X CORE CABINET EXAMPLE

**PN Example: MCC201-02**

**2-Bay CORE CABINET, Righthand Door, Keypad Lock**

# CORE | ACCESSORIES

## CART

### TRAYS & BASKETS - LIGHT GREY



**MCT601**  
2" Tray



**MCT602**  
4" Tray



**MCT603**  
8" Tray



**MCT604**  
4" Basket



**MCT605**  
8" Basket

### DIVIDERS - LIGHT GREY



#### 2" DIVIDERS

**MCT606** - 2 x 16" HW

**MCT607** - 2 x 24" HW



#### 4" DIVIDERS

**MCT610** - 4 x 16" HW

**MCT611** - 4 x 24" HW

#### 8" DIVIDERS

**MCT612** - 8 x 16" HW

**MCT613** - 8 x 24" HW

### MISCELLANEOUS ACCESSORIES



**MCT615**  
Label Holder



**MCT616**  
White Label Card For Holder



**MCT614**  
Tray Stop

# CORE | ACCESSORIES

## CART

### SHELVES AND RACKS



**MCT617**  
Cath Manager - 9 Hooks



**MCT624**  
Cath Manager - Under Shelf  
(Shelf Not Included)



#### METAL SHELVES

- MCT618** - 13.5" x 23.5" WD
- MCT619** - 33" x 23.5" WD
- MCT619-HD** - 33" x 23.5" WD

#### SHELF DIVIDERS

- MCT622** - 6" x 13.5" HD

### LOCK UPGRADES - \*FIELD INSTALLATION



#### KEYLESS ELECTRONIC KEYPAD

- MCT523** - Standard Keypad
- MCT524** - Proximity Card HID Access
- MCT525** - IClass HID Access High Frequency



#### MCT522 Disk Lock

(Includes 2 Keys)

# CORE | ACCESSORIES

## CART

### SLOPED TOP



2-Sided



1-Sided

#### CART SLOPED TOP

- MCT625** - 1-Bay, 2-Sided
- MCT620** - 2-Bay, 2-Sided
- MCT621** - 3-Bay, 2-Sided

#### CABINET SLOPED TOP

- MCC626** - 1-Bay, 1-Sided
- MCC627** - 2-Bay, 1-Sided
- MCC628** - 3-Bay, 1-Sided

### SLOPE TOP



**MCT628** - Vertical Rail Kit Pair (72" H)

- Same corner extrusions as STAT Cart
- Extended length equipment rail
- Compatible with all STAT accessories that use Fairfield rail



**MCT627**  
**26.25" W**  
**Side Accessory Rail Kit**  
(Extrusion Mount)

\*Compatible with STAT CART Accessories



**MCT629**  
**26.185" W**  
**Side Handle**  
(Extrusion Mount)

**MCT630**  
**26.185" W**  
**Replacement Side Handle**

# CORE CART | 3-BAY

**MCT300-XX-XXXX**



**MCT301-XX-XXXX**



**MCT302-XX-XXXX**



**MCT300-XX-XC3F**



PART #	QTY	DESCRIPTION
MCT601-KT	-	2" Tray, Lt Gray - Loaded w/ Dividers
MCT602-KT	7	4" Tray, Lt Gray - Loaded w/ Dividers
MCT603-KT	2	8" Tray, Lt Gray - Loaded w/ Dividers
MCT604-KT	-	4" Basket, Lt Gray - Loaded w/ Dividers
MCT605-KT	1	8" Basket, Lt Gray - Loaded w/ Dividers
MCT617	6	Upper Cath Manager
MCT618	7	18" Metal Shelf
MCT619	-	36" Metal Shelf
MCT615	10	Plastic Label Holder
MCT616	10	Label Card

**MCT300-XX-XG3A**



PART #	QTY	DESCRIPTION
MCT601-KT	3	2" Tray, Lt Gray - Loaded w/ Dividers
MCT602-KT	4	4" Tray, Lt Gray - Loaded w/ Dividers
MCT603-KT	3	8" Tray, Lt Gray - Loaded w/ Dividers
MCT604-KT	2	4" Basket, Lt Gray - Loaded w/ Dividers
MCT605-KT	3	8" Basket, Lt Gray - Loaded w/ Dividers
MCT617	-	Upper Cath Manager
MCT618	4	18" Metal Shelf
MCT619	-	36" Metal Shelf
MCT615	15	Plastic Label Holder
MCT616	15	Label Card

**MCT300-XX-XG3B**



PART #	QTY	DESCRIPTION
MCT601-KT	1	2" Tray, Lt Gray - Loaded w/ Dividers
MCT602-KT	3	4" Tray, Lt Gray - Loaded w/ Dividers
MCT603-KT	-	8" Tray, Lt Gray - Loaded w/ Dividers
MCT604-KT	3	4" Basket, Lt Gray - Loaded w/ Dividers
MCT605-KT	-	8" Basket, Lt Gray - Loaded w/ Dividers
MCT617	-	Upper Cath Manager
MCT618	6	18" Metal Shelf
MCT619	-	36" Metal Shelf
MCT615	7	Plastic Label Holder
MCT616	7	Label Card

# CORE CART | 3-BAY

## MCT300-XX-XG3E



PART #	QTY	DESCRIPTION
MCT601-KT	6	2" Tray, Lt Gray - Loaded w/ Dividers
MCT602-KT	-	4" Tray, Lt Gray - Loaded w/ Dividers
MCT603-KT	-	8" Tray, Lt Gray - Loaded w/ Dividers
MCT604-KT	12	4" Basket, Lt Gray - Loaded w/ Dividers
MCT605-KT	6	8" Basket, Lt Gray - Loaded w/ Dividers
MCT617	-	Upper Cath Manager
MCT618	3	18" Metal Shelf
MCT619	-	36" Metal Shelf
MCT615	30	Plastic Label Holder
MCT616	30	Label Card

## MCT300-XX-XG3F



PART #	QTY	DESCRIPTION
MCT601-KT	6	2" Tray, Lt Gray - Loaded w/ Dividers
MCT602-KT	15	4" Tray, Lt Gray - Loaded w/ Dividers
MCT603-KT	6	8" Tray, Lt Gray - Loaded w/ Dividers
MCT604-KT	-	4" Basket, Lt Gray - Loaded w/ Dividers
MCT605-KT	-	8" Basket, Lt Gray - Loaded w/ Dividers
MCT617	-	Upper Cath Manager
MCT618	3	18" Metal Shelf
MCT619	-	36" Metal Shelf
MCT615	27	Plastic Label Holder
MCT616	27	Label Card

## MCT300-XX-XG3G



PART #	QTY	DESCRIPTION
MCT601-KT	2	2" Tray, Lt Gray - Loaded w/ Dividers
MCT602-KT	8	4" Tray, Lt Gray - Loaded w/ Dividers
MCT603-KT	4	8" Tray, Lt Gray - Loaded w/ Dividers
MCT604-KT	-	4" Basket, Lt Gray - Loaded w/ Dividers
MCT605-KT	-	8" Basket, Lt Gray - Loaded w/ Dividers
MCT617	-	Upper Cath Manager
MCT618	8	18" Metal Shelf
MCT619	-	36" Metal Shelf
MCT615	14	Plastic Label Holder
MCT616	14	Label Card

## MCT300-XX-XS3A



PART #	QTY	DESCRIPTION
MCT601-KT	-	2" Tray, Lt Gray - Loaded w/ Dividers
MCT602-KT	-	4" Tray, Lt Gray - Loaded w/ Dividers
MCT603-KT	-	8" Tray, Lt Gray - Loaded w/ Dividers
MCT604-KT	-	4" Basket, Lt Gray - Loaded w/ Dividers
MCT605-KT	-	8" Basket, Lt Gray - Loaded w/ Dividers
MCT617	-	Upper Cath Manager
MCT618	15	18" Metal Shelf
MCT619	-	36" Metal Shelf
MCT615	-	Plastic Label Holder
MCT616	-	Label Card

# CORE CART | 3-BAY

## MCT301-XX-XC3A



PART #	QTY	DESCRIPTION
MCT601-KT	2	2" Tray, Lt Gray - Loaded w/ Dividers
MCT602-KT	2	4" Tray, Lt Gray - Loaded w/ Dividers
MCT603-KT	1	8" Tray, Lt Gray - Loaded w/ Dividers
MCT604-KT	-	4" Basket, Lt Gray - Loaded w/ Dividers
MCT605-KT	1	8" Basket, Lt Gray - Loaded w/ Dividers
MCT617	7	Upper Cath Manager
MCT618	1	18" Metal Shelf
MCT619	-	36" Metal Shelf
MCT615	6	Plastic Label Holder
MCT616	6	Label Card

## MCT302-XX-XC3A



## MCT301-XX-XC3B



PART #	QTY	DESCRIPTION
MCT601-KT	-	2" Tray, Lt Gray - Loaded w/ Dividers
MCT602-KT	-	4" Tray, Lt Gray - Loaded w/ Dividers
MCT603-KT	-	8" Tray, Lt Gray - Loaded w/ Dividers
MCT604-KT	-	4" Basket, Lt Gray - Loaded w/ Dividers
MCT605-KT	-	8" Basket, Lt Gray - Loaded w/ Dividers
MCT617	7	Upper Cath Manager
MCT618	4	18" Metal Shelf
MCT619	-	36" Metal Shelf
MCT615	-	Plastic Label Holder
MCT616	-	Label Card

## MCT302-XX-XC3B



## MCT301-XX-XC3C



PART #	QTY	DESCRIPTION
MCT601-KT	1	2" Tray, Lt Gray - Loaded w/ Dividers
MCT602-KT	2	4" Tray, Lt Gray - Loaded w/ Dividers
MCT603-KT	-	8" Tray, Lt Gray - Loaded w/ Dividers
MCT604-KT	-	4" Basket, Lt Gray - Loaded w/ Dividers
MCT605-KT	1	8" Basket, Lt Gray - Loaded w/ Dividers
MCT617	7	Upper Cath Manager
MCT618	2	18" Metal Shelf
MCT619	-	36" Metal Shelf
MCT615	4	Plastic Label Holder
MCT616	4	Label Card

## MCT302-XX-XC3C



## MCT301-XX-XC3D



PART #	QTY	DESCRIPTION
MCT601-KT	-	2" Tray, Lt Gray - Loaded w/ Dividers
MCT602-KT	-	4" Tray, Lt Gray - Loaded w/ Dividers
MCT603-KT	-	8" Tray, Lt Gray - Loaded w/ Dividers
MCT604-KT	-	4" Basket, Lt Gray - Loaded w/ Dividers
MCT605-KT	-	8" Basket, Lt Gray - Loaded w/ Dividers
MCT617	9	Upper Cath Manager
MCT618	-	18" Metal Shelf
MCT619	-	36" Metal Shelf
MCT615	-	Plastic Label Holder
MCT616	-	Label Card

## MCT302-XX-XC3D



# CORE CART | 3-BAY

## MCT301-XX-XC3E



PART #	QTY	DESCRIPTION
MCT601-KT	1	2" Tray, Lt Gray - Loaded w/ Dividers
MCT602-KT	5	4" Tray, Lt Gray - Loaded w/ Dividers
MCT603-KT	2	8" Tray, Lt Gray - Loaded w/ Dividers
MCT604-KT	-	4" Basket, Lt Gray - Loaded w/ Dividers
MCT605-KT	-	8" Basket, Lt Gray - Loaded w/ Dividers
MCT617	6	Upper Cath Manager
MCT618	1	18" Metal Shelf
MCT619	-	36" Metal Shelf
MCT615	8	Plastic Label Holder
MCT616	8	Label Card

## MCT302-XX-XC3E



## MCT301-XX-XG3C



PART #	QTY	DESCRIPTION
MCT601-KT	1	2" Tray, Lt Gray - Loaded w/ Dividers
MCT602-KT	3	4" Tray, Lt Gray - Loaded w/ Dividers
MCT603-KT	1	8" Tray, Lt Gray - Loaded w/ Dividers
MCT604-KT	-	4" Basket, Lt Gray - Loaded w/ Dividers
MCT605-KT	-	8" Basket, Lt Gray - Loaded w/ Dividers
MCT617	-	Upper Cath Manager
MCT618	1	18" Metal Shelf
MCT619	5	36" Metal Shelf
MCT615	6	Plastic Label Holder
MCT616	6	Label Card

## MCT302-XX-XG3C



## MCT301-XX-XG3D



PART #	QTY	DESCRIPTION
MCT601-KT	2	2" Tray, Lt Gray - Loaded w/ Dividers
MCT602-KT	4	4" Tray, Lt Gray - Loaded w/ Dividers
MCT603-KT	1	8" Tray, Lt Gray - Loaded w/ Dividers
MCT604-KT	-	4" Basket, Lt Gray - Loaded w/ Dividers
MCT605-KT	-	8" Basket, Lt Gray - Loaded w/ Dividers
MCT617	-	Upper Cath Manager
MCT618	1	18" Metal Shelf
MCT619	6	36" Metal Shelf
MCT615	7	Plastic Label Holder
MCT616	7	Label Card

## MCT302-XX-XG3D



## MCT301-XX-XS3B



PART #	QTY	DESCRIPTION
MCT601-KT	-	2" Tray, Lt Gray - Loaded w/ Dividers
MCT602-KT	-	4" Tray, Lt Gray - Loaded w/ Dividers
MCT603-KT	-	8" Tray, Lt Gray - Loaded w/ Dividers
MCT604-KT	-	4" Basket, Lt Gray - Loaded w/ Dividers
MCT605-KT	-	8" Basket, Lt Gray - Loaded w/ Dividers
MCT617	-	Upper Cath Manager
MCT618	5	18" Metal Shelf
MCT619	5	36" Metal Shelf
MCT615	-	Plastic Label Holder
MCT616	-	Label Card

## MCT302-XX-XS3B



# CORE CART | 2-BAY

**MCT200-XX-XXXX**



**MCT201-XX-XXXX**

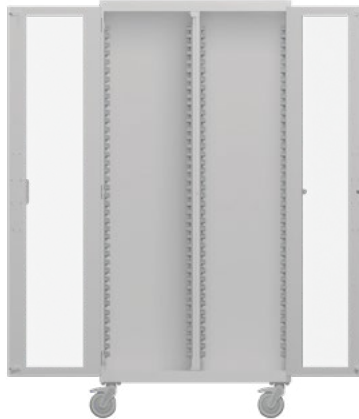

**MCT202-XX-XXXX**

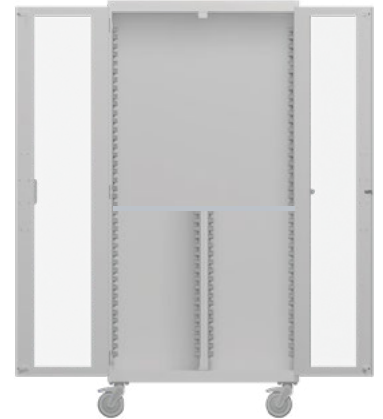

**MCT200-XX-XC2B**



PART #	QTY	DESCRIPTION
MCT601-KT	-	2" Tray, Lt Gray - Loaded w/ Dividers
MCT602-KT	-	4" Tray, Lt Gray - Loaded w/ Dividers
MCT603-KT	-	8" Tray, Lt Gray - Loaded w/ Dividers
MCT604-KT	-	4" Basket, Lt Gray - Loaded w/ Dividers
MCT605-KT	-	8" Basket, Lt Gray - Loaded w/ Dividers
MCT617	7	Upper Cath Manager
MCT618	-	18" Metal Shelf
MCT619	-	36" Metal Shelf
MCT615	-	Plastic Label Holder
MCT616	-	Label Card

**MCT200-XX-XS2B**



PART #	QTY	DESCRIPTION
MCT601-KT	-	2" Tray, Lt Gray - Loaded w/ Dividers
MCT602-KT	-	4" Tray, Lt Gray - Loaded w/ Dividers
MCT603-KT	-	8" Tray, Lt Gray - Loaded w/ Dividers
MCT604-KT	-	4" Basket, Lt Gray - Loaded w/ Dividers
MCT605-KT	-	8" Basket, Lt Gray - Loaded w/ Dividers
MCT617	-	Upper Cath Manager
MCT618	-	18" Metal Shelf
MCT619	5	36" Metal Shelf
MCT615	-	Plastic Label Holder
MCT616	-	Label Card

**MCT200-XX-XS2D**



PART #	QTY	DESCRIPTION
MCT601-KT	-	2" Tray, Lt Gray - Loaded w/ Dividers
MCT602-KT	-	4" Tray, Lt Gray - Loaded w/ Dividers
MCT603-KT	-	8" Tray, Lt Gray - Loaded w/ Dividers
MCT604-KT	-	4" Basket, Lt Gray - Loaded w/ Dividers
MCT605-KT	-	8" Basket, Lt Gray - Loaded w/ Dividers
MCT617	-	Upper Cath Manager
MCT618	-	18" Metal Shelf
MCT619	8	36" Metal Shelf
MCT615	-	Plastic Label Holder
MCT616	-	Label Card

# CORE CART | 2-BAY

## MCT201-XX-XC2A

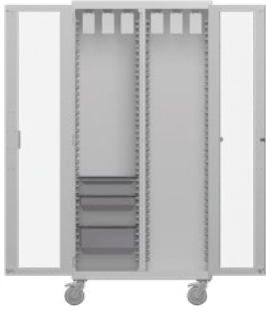

PART #	QTY	DESCRIPTION
MCT601-KT	1	2" Tray, Lt Gray - Loaded w/ Dividers
MCT602-KT	1	4" Tray, Lt Gray - Loaded w/ Dividers
MCT603-KT	1	8" Tray, Lt Gray - Loaded w/ Dividers
MCT604-KT	-	4" Basket, Lt Gray - Loaded w/ Dividers
MCT605-KT	-	8" Basket, Lt Gray - Loaded w/ Dividers
MCT617	6	Upper Cath Manager
MCT618	-	18" Metal Shelf
MCT619	-	36" Metal Shelf
MCT615	3	Plastic Label Holder
MCT616	3	Label Card

## MCT201-XX-XC2C

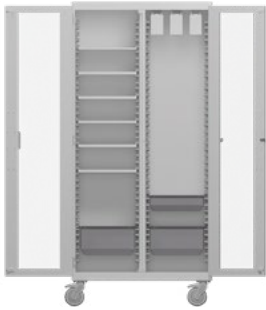

PART #	QTY	DESCRIPTION
MCT601-KT	-	2" Tray, Lt Gray - Loaded w/ Dividers
MCT602-KT	1	4" Tray, Lt Gray - Loaded w/ Dividers
MCT603-KT	2	8" Tray, Lt Gray - Loaded w/ Dividers
MCT604-KT	-	4" Basket, Lt Gray - Loaded w/ Dividers
MCT605-KT	-	8" Basket, Lt Gray - Loaded w/ Dividers
MCT617	3	Upper Cath Manager
MCT618	6	18" Metal Shelf
MCT619	-	36" Metal Shelf
MCT615	3	Plastic Label Holder
MCT616	3	Label Card

## MCT201-XX-XC2D

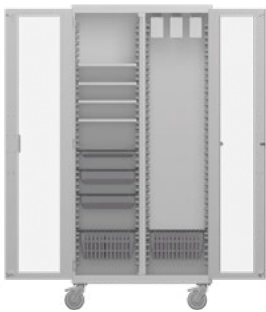

PART #	QTY	DESCRIPTION
MCT601-KT	1	2" Tray, Lt Gray - Loaded w/ Dividers
MCT602-KT	2	4" Tray, Lt Gray - Loaded w/ Dividers
MCT603-KT	-	8" Tray, Lt Gray - Loaded w/ Dividers
MCT604-KT	-	4" Basket, Lt Gray - Loaded w/ Dividers
MCT605-KT	2	8" Basket, Lt Gray - Loaded w/ Dividers
MCT617	3	Upper Cath Manager
MCT618	4	18" Metal Shelf
MCT619	-	36" Metal Shelf
MCT615	5	Plastic Label Holder
MCT616	5	Label Card

## MCT201-XX-XG2A



PART #	QTY	DESCRIPTION
MCT601-KT	4	2" Tray, Lt Gray - Loaded w/ Dividers
MCT602-KT	4	4" Tray, Lt Gray - Loaded w/ Dividers
MCT603-KT	2	8" Tray, Lt Gray - Loaded w/ Dividers
MCT604-KT	-	4" Basket, Lt Gray - Loaded w/ Dividers
MCT605-KT	2	8" Basket, Lt Gray - Loaded w/ Dividers
MCT617	-	Upper Cath Manager
MCT618	-	18" Metal Shelf
MCT619	-	36" Metal Shelf
MCT615	12	Plastic Label Holder
MCT616	12	Label Card

# CORE CART | 2-BAY

## MCT201-XX-XG2B



PART #	QTY	DESCRIPTION
MCT601-KT	3	2" Tray, Lt Gray - Loaded w/ Dividers
MCT602-KT	3	4" Tray, Lt Gray - Loaded w/ Dividers
MCT603-KT	-	8" Tray, Lt Gray - Loaded w/ Dividers
MCT604-KT	2	4" Basket, Lt Gray - Loaded w/ Dividers
MCT605-KT	2	8" Basket, Lt Gray - Loaded w/ Dividers
MCT617	-	Upper Cath Manager
MCT618	3	18" Metal Shelf
MCT619	-	36" Metal Shelf
MCT615	10	Plastic Label Holder
MCT616	10	Label Card

## MCT201-XX-XG2C



PART #	QTY	DESCRIPTION
MCT601-KT	3	2" Tray, Lt Gray - Loaded w/ Dividers
MCT602-KT	4	4" Tray, Lt Gray - Loaded w/ Dividers
MCT603-KT	-	8" Tray, Lt Gray - Loaded w/ Dividers
MCT604-KT	1	4" Basket, Lt Gray - Loaded w/ Dividers
MCT605-KT	1	8" Basket, Lt Gray - Loaded w/ Dividers
MCT617	-	Upper Cath Manager
MCT618	2	18" Metal Shelf
MCT619	-	36" Metal Shelf
MCT615	9	Plastic Label Holder
MCT616	9	Label Card

## MCT201-XX-XG2D



PART #	QTY	DESCRIPTION
MCT601-KT	4	2" Tray, Lt Gray - Loaded w/ Dividers
MCT602-KT	4	4" Tray, Lt Gray - Loaded w/ Dividers
MCT603-KT	-	8" Tray, Lt Gray - Loaded w/ Dividers
MCT604-KT	2	4" Basket, Lt Gray - Loaded w/ Dividers
MCT605-KT	2	8" Basket, Lt Gray - Loaded w/ Dividers
MCT617	-	Upper Cath Manager
MCT618	2	18" Metal Shelf
MCT619	-	36" Metal Shelf
MCT615	12	Plastic Label Holder
MCT616	12	Label Card

## MCT201-XX-XG2E



PART #	QTY	DESCRIPTION
MCT601-KT	2	2" Tray, Lt Gray - Loaded w/ Dividers
MCT602-KT	4	4" Tray, Lt Gray - Loaded w/ Dividers
MCT603-KT	2	8" Tray, Lt Gray - Loaded w/ Dividers
MCT604-KT	4	4" Basket, Lt Gray - Loaded w/ Dividers
MCT605-KT	2	8" Basket, Lt Gray - Loaded w/ Dividers
MCT617	-	Upper Cath Manager
MCT618	8	18" Metal Shelf
MCT619	-	36" Metal Shelf
MCT615	14	Plastic Label Holder
MCT616	14	Label Card

# CORE CART | 2-BAY

## MCT201-XX-XG2F



PART #	QTY	DESCRIPTION
MCT601-KT	4	2" Tray, Lt Gray - Loaded w/ Dividers
MCT602-KT	6	4" Tray, Lt Gray - Loaded w/ Dividers
MCT603-KT	-	8" Tray, Lt Gray - Loaded w/ Dividers
MCT604-KT	1	4" Basket, Lt Gray - Loaded w/ Dividers
MCT605-KT	1	8" Basket, Lt Gray - Loaded w/ Dividers
MCT617	6	Upper Cath Manager
MCT618	4	18" Metal Shelf
MCT619	-	36" Metal Shelf
MCT615	12	Plastic Label Holder
MCT616	12	Label Card

## MCT201-XX-XG2G



PART #	QTY	DESCRIPTION
MCT601-KT	-	2" Tray, Lt Gray - Loaded w/ Dividers
MCT602-KT	-	4" Tray, Lt Gray - Loaded w/ Dividers
MCT603-KT	-	8" Tray, Lt Gray - Loaded w/ Dividers
MCT604-KT	4	4" Basket, Lt Gray - Loaded w/ Dividers
MCT605-KT	6	8" Basket, Lt Gray - Loaded w/ Dividers
MCT617	-	Upper Cath Manager
MCT618	6	18" Metal Shelf
MCT619	-	36" Metal Shelf
MCT615	10	Plastic Label Holder
MCT616	10	Label Card

## MCT201-XX-XG2H



PART #	QTY	DESCRIPTION
MCT601-KT	4	2" Tray, Lt Gray - Loaded w/ Dividers
MCT602-KT	6	4" Tray, Lt Gray - Loaded w/ Dividers
MCT603-KT	4	8" Tray, Lt Gray - Loaded w/ Dividers
MCT604-KT	-	4" Basket, Lt Gray - Loaded w/ Dividers
MCT605-KT	-	8" Basket, Lt Gray - Loaded w/ Dividers
MCT617	-	Upper Cath Manager
MCT618	2	18" Metal Shelf
MCT619	-	36" Metal Shelf
MCT615	14	Plastic Label Holder
MCT616	14	Label Card

## MCT201-XX-XG2I



PART #	QTY	DESCRIPTION
MCT601-KT	4	2" Tray, Lt Gray - Loaded w/ Dividers
MCT602-KT	12	4" Tray, Lt Gray - Loaded w/ Dividers
MCT603-KT	2	8" Tray, Lt Gray - Loaded w/ Dividers
MCT604-KT	-	4" Basket, Lt Gray - Loaded w/ Dividers
MCT605-KT	-	8" Basket, Lt Gray - Loaded w/ Dividers
MCT617	-	Upper Cath Manager
MCT618	2	18" Metal Shelf
MCT619	-	36" Metal Shelf
MCT615	18	Plastic Label Holder
MCT616	18	Label Card

# CORE CART | 2-BAY

## MCT201-XX-XG2J

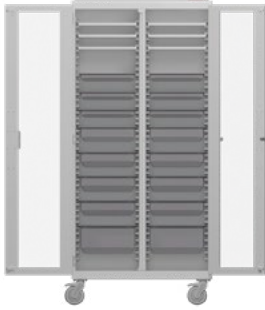

PART #	QTY	DESCRIPTION
MCT601-KT	6	2" Tray, Lt Gray - Loaded w/ Dividers
MCT602-KT	8	4" Tray, Lt Gray - Loaded w/ Dividers
MCT603-KT	2	8" Tray, Lt Gray - Loaded w/ Dividers
MCT604-KT	-	4" Basket, Lt Gray - Loaded w/ Dividers
MCT605-KT	-	8" Basket, Lt Gray - Loaded w/ Dividers
MCT617	-	Upper Cath Manager
MCT618	6	18" Metal Shelf
MCT619	-	36" Metal Shelf
MCT615	16	Plastic Label Holder
MCT616	16	Label Card

## MCT201-XX-XG2K



PART #	QTY	DESCRIPTION
MCT601-KT	2	2" Tray, Lt Gray - Loaded w/ Dividers
MCT602-KT	3	4" Tray, Lt Gray - Loaded w/ Dividers
MCT603-KT	1	8" Tray, Lt Gray - Loaded w/ Dividers
MCT604-KT	2	4" Basket, Lt Gray - Loaded w/ Dividers
MCT605-KT	2	8" Basket, Lt Gray - Loaded w/ Dividers
MCT617	-	Upper Cath Manager
MCT618	4	18" Metal Shelf
MCT619	-	36" Metal Shelf
MCT615	10	Plastic Label Holder
MCT616	10	Label Card

## MCT201-XX-XG2L



PART #	QTY	DESCRIPTION
MCT601-KT	2	2" Tray, Lt Gray - Loaded w/ Dividers
MCT602-KT	8	4" Tray, Lt Gray - Loaded w/ Dividers
MCT603-KT	2	8" Tray, Lt Gray - Loaded w/ Dividers
MCT604-KT	-	4" Basket, Lt Gray - Loaded w/ Dividers
MCT605-KT	-	8" Basket, Lt Gray - Loaded w/ Dividers
MCT617	-	Upper Cath Manager
MCT618	2	18" Metal Shelf
MCT619	-	36" Metal Shelf
MCT615	12	Plastic Label Holder
MCT616	12	Label Card

## MCT201-XX-XS2A



PART #	QTY	DESCRIPTION
MCT601-KT	-	2" Tray, Lt Gray - Loaded w/ Dividers
MCT602-KT	-	4" Tray, Lt Gray - Loaded w/ Dividers
MCT603-KT	-	8" Tray, Lt Gray - Loaded w/ Dividers
MCT604-KT	-	4" Basket, Lt Gray - Loaded w/ Dividers
MCT605-KT	-	8" Basket, Lt Gray - Loaded w/ Dividers
MCT617	-	Upper Cath Manager
MCT618	10	18" Metal Shelf
MCT619	-	36" Metal Shelf
MCT615	-	Plastic Label Holder
MCT616	-	Label Card

# CORE | 1-BAY CART



## PART NUMBER

### MCT100 -

CC =  
Cabinet

Door  
Opening

Lock  
Option

Handle  
Option

**L** = Left Door  
**R** = Right Door

**0** = No Lock  
**1** = Key Lock  
**2** = Key Pad  
**3** = Prox Low Freq  
**4** = Prox High Freq

**HL** = Left Handle  
**HR** = Right Handle  
**H** = Both Handles  
= No Handles

**PN Example: MCT100-R0-H**

**1 BAY, CORE CART, Right-hand Door, No Lock, Both Handles**

\*Accessories not included







# CORE BENCH

This procedure back table bench brings surgical supplies to the point of care, increasing procedure efficiency and maximizing your procedure room storage. These cabinets can store peel packs, disposables, and other essentials right where you need them at the point of care.

The CORE BENCH was designed specifically for use in the healthcare industry. This high-quality logistic system is ISO 3394 standardized and can be used in all departments of the hospital. Work top options include 3/4" thick Stainless Steel or Phenolic, perfect for durability and infection control. The storage accepts the same tray system from CORE CART.



**EVERHUTCH**

# CORE BENCH



## PART NUMBER

**MBN** \_\_\_\_\_ - \_\_\_\_\_ - \_\_\_\_\_ **G2N**  
 Bay Option Lock Option Handle Top Option Package Option

PN Example: MBN201-01-HRSSG2N  
 2-BAY, CORE Bench, Disk Lock, Rightside Handle, Stainless Steel Top

# CORE BENCH

# SPECIFICATION



CORE Bench Package **G2N**

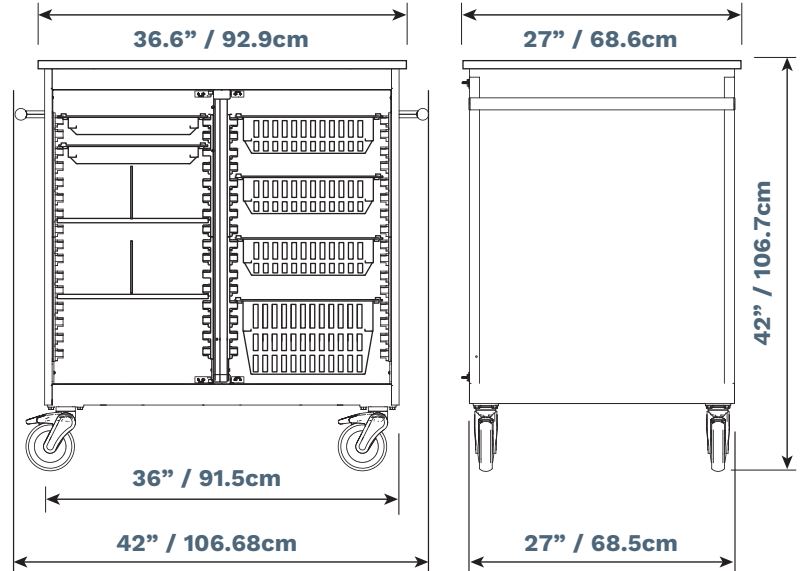

## KEY FEATURES

### Maneuvers easily

- Customized solutions for Cath labs, IR labs, and General Storage.
- Robust design
- 5" Locking swivel casters

### Customizable

- 21 Accessory packages available
- 29 Individual accessories available
- Handle configurations & 2 Work top options

### Adaptable to Your Workflow

- Adaptable as needs change with various accessory packages
- Interchangeable components with EVERHUTCH solutions
- Accommodates variety of medical equipment
- Configure your own custom CORE Bench

## SPECIFICATIONS

- Dimensions: 42 x 42 x 27" HWD
- Weight: 250 LB
- Caster Wheel 5"

### Certifications

- Conforms to UL 60601

### Finish

- Snow White Powder Coat

### Side Handles

- Brushed Aluminum

### Warranty

- Refer to EVERHUTCH.com for complete warranty information

## PART NUMBER

**MBN201 - - G2N**

Lock Option

Handle

Top Option

Package Option

**00** = No Lock

**01** = Key Lock

**02** = Key Pad

**03** = Prox Low Freq

**04** = Prox High Freq

**HL** = Left Handle

**HR** = Right Handle

**H** = Both Handles

= No Handles

**SS** = 3/4" Stainless Steel

**PH** = 3/4" Phenolic

PN Example: **MBN201-01-HRSSG2N**

**2-BAY, CORE Bench, Disk Lock, Rightside Handle, Stainless Steel Top**

# CORE BENCH | CONFIGURATIONS

## MBN200



PART #	QTY	DESCRIPTION
MCT601-KT	-	2" Tray, Lt Gray - Loaded w/ Dividers
MCT602-KT	-	4" Tray, Lt Gray - Loaded w/ Dividers
MCT603-KT	-	8" Tray, Lt Gray - Loaded w/ Dividers
MCT604-KT	-	4" Basket, Lt Gray - Loaded w/ Dividers
MCT605-KT	-	8" Basket, Lt Gray - Loaded w/ Dividers
MCT618	-	18" Metal Shelf
MCT619	-	36" Metal Shelf
MCT615	-	Plastic Label Holder
MCT616	-	Label Card

## MBN201



PART #	QTY	DESCRIPTION
MCT601-KT	-	2" Tray, Lt Gray - Loaded w/ Dividers
MCT602-KT	-	4" Tray, Lt Gray - Loaded w/ Dividers
MCT603-KT	-	8" Tray, Lt Gray - Loaded w/ Dividers
MCT604-KT	-	4" Basket, Lt Gray - Loaded w/ Dividers
MCT605-KT	-	8" Basket, Lt Gray - Loaded w/ Dividers
MCT618	-	18" Metal Shelf
MCT619	-	36" Metal Shelf
MCT615	-	Plastic Label Holder
MCT616	-	Label Card

## MBNS2E



PART #	QTY	DESCRIPTION
MCT601-KT	-	2" Tray, Lt Gray - Loaded w/ Dividers
MCT602-KT	-	4" Tray, Lt Gray - Loaded w/ Dividers
MCT603-KT	-	8" Tray, Lt Gray - Loaded w/ Dividers
MCT604-KT	-	4" Basket, Lt Gray - Loaded w/ Dividers
MCT605-KT	-	8" Basket, Lt Gray - Loaded w/ Dividers
MCT618	-	18" Metal Shelf
MCT619	2	36" Metal Shelf
MCT622	4	Dividers

## MBNS2F



PART #	QTY	DESCRIPTION
MCT601-KT	-	2" Tray, Lt Gray - Loaded w/ Dividers
MCT602-KT	-	4" Tray, Lt Gray - Loaded w/ Dividers
MCT603-KT	-	8" Tray, Lt Gray - Loaded w/ Dividers
MCT604-KT	-	4" Basket, Lt Gray - Loaded w/ Dividers
MCT605-KT	-	8" Basket, Lt Gray - Loaded w/ Dividers
MCT618	6	18" Metal Shelf
MCT619	-	36" Metal Shelf
MCT622	6	Dividers

# CORE BENCH | CONFIGURATIONS

## MBNG2M



PART #	QTY	DESCRIPTION
MCT601-KT	-	2" Tray, Lt Gray - Loaded w/ Dividers
MCT602-KT	-	4" Tray, Lt Gray - Loaded w/ Dividers
MCT603-KT	-	8" Tray, Lt Gray - Loaded w/ Dividers
MCT604-KT	4	4" Basket, Lt Gray - Loaded w/ Dividers
MCT605-KT	4	8" Basket, Lt Gray - Loaded w/ Dividers
MCT618	-	18" Metal Shelf
MCT619	-	36" Metal Shelf
MCT615	-	Plastic Label Holder
MCT616	-	Label Card

## MBNG2N



PART #	QTY	DESCRIPTION
MCT601-KT	2	2" Tray, Lt Gray - Loaded w/ Dividers
MCT602-KT	-	4" Tray, Lt Gray - Loaded w/ Dividers
MCT603-KT	-	8" Tray, Lt Gray - Loaded w/ Dividers
MCT604-KT	3	4" Basket, Lt Gray - Loaded w/ Dividers
MCT605-KT	1	8" Basket, Lt Gray - Loaded w/ Dividers
MCT618	2	18" Metal Shelf
MCT619	-	36" Metal Shelf
MCT615	6	Plastic Label Holder
MCT616	6	Label Card
MCT622	2	Dividers

## MBNG2O



PART #	QTY	DESCRIPTION
MCT601-KT	8	2" Tray, Lt Gray - Loaded w/ Dividers
MCT602-KT	-	4" Tray, Lt Gray - Loaded w/ Dividers
MCT603-KT	-	8" Tray, Lt Gray - Loaded w/ Dividers
MCT604-KT	2	4" Basket, Lt Gray - Loaded w/ Dividers
MCT605-KT	2	8" Basket, Lt Gray - Loaded w/ Dividers
MCT618	-	18" Metal Shelf
MCT619	-	36" Metal Shelf
MCT615	12	Plastic Label Holder
MCT616	12	Label Card

## MBNG2P



PART #	QTY	DESCRIPTION
MCT601-KT	-	2" Tray, Lt Gray - Loaded w/ Dividers
MCT602-KT	-	4" Tray, Lt Gray - Loaded w/ Dividers
MCT603-KT	-	8" Tray, Lt Gray - Loaded w/ Dividers
MCT604-KT	6	4" Basket, Lt Gray - Loaded w/ Dividers
MCT605-KT	2	8" Basket, Lt Gray - Loaded w/ Dividers
MCT618	-	18" Metal Shelf
MCT619	-	36" Metal Shelf
MCT615	-	Plastic Label Holder
MCT616	-	Label Card



# NEST CART

## **Maneuvers easily**

- Heavy duty construction
- Conforms to UL 60601
- 3" Locking swivel casters

## **Supports thorough cleaning**

- Integrated seams
- Smooth exposed surfaces
- Chemical resistant powder coat
- Supports infection control practices

## **Security**

- Key Lock available
- Self-closing drawers

## **Adaptable to any environment**

- Ideal for areas with limited space
- Standalone or "NEST" under table
- Full-extension drawers
- Soft-touch closing drawers

## **Adapts to your Workflow**

- 31 Configurations of NESTCART
- Accommodates a variety of medical equipment



# NEST CART | 3 HEIGHTS

**STANDING 36"**



**ADA 33"**



**SITTING 30"**

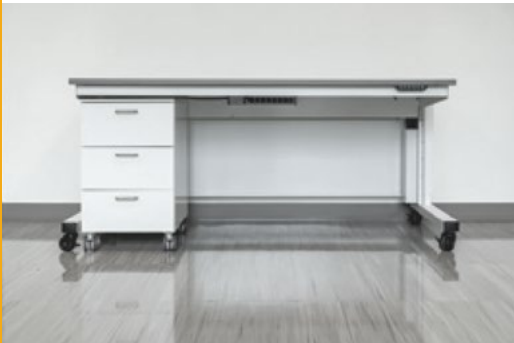

# NEST | PART CART | NUMBERS

## MCB03C

Height	Width	Door Swing	Lock Option
30"	18"	L = Left	00 = No Lock
33"	24"	R = Right	01 = Key Lock
36"	30"		

	STANDING 36"	ADA 33"	SITTING 30"
<b>SINGLE DOOR</b>	MCB03C3624LM-00 MCB03C3624LM-01 MCB03C3624RM-00 MCB03C3624RM-01	MCB03C3324LM-00 MCB03C3324LM-01 MCB03C3324RM-00 MCB03C3324RM-01	MCB03C3024LM-00 MCB03C3024LM-01 MCB03C3024RM-00 MCB03C3024RM-01
<b>SINGLE DOOR &amp; DRAWER</b>			MCB40E3024LM-00 MCB40E3024LM-01 MCB40E3024RM-00 MCB40E3024RM-01
<b>3-DRAWER</b>	MCB00D3618M-00 MCB00D3618M-01 MCB00D3624M-00 MCB00D3624M-01 MCB00D3630M-00 MCB00D3630M-01	MCB00D3318M-00 MCB00D3318M-01 MCB00D3324M-00 MCB00D3324M-01 MCB85D3324M-00	MCB00D3018M-00 MCB00D3018M-01 MCB00D3024M-00 MCB00D3024M-01 MCB00D3030M-00 MCB00D3030M-01
<b>3-DRAWER &amp; PULLOUT BOARD</b>			MCB26D3018M-00 MCB26D3018M-01 MCB26D3024M-00 MCB26D3024M-01
<b>4-DRAWER</b>	MCB08D3618M-00 MCB08D3618M-01 MCB08D3624M-00 MCB08D3624M-01 MCB30D3618M-00 MCB30D3618M-01 MCB30D3624M-00 MCB30D3624M-01 MCB30D3630M-00 MCB30D3630M-01	MCB30D3318M-00 MCB30D3318M-01 MCB30D3324M-00 MCB30D3324M-01	MCB30D3018M-00 MCB30D3018M-01 MCB30D3024M-00 MCB30D3024M-01 MCB30D3030M-00 MCB30D3030M-01
<b>5-DRAWER</b>	MCB50D3618M-00 MCB50D3618M-01 MCB50D3624M-00 MCB50D3624M-01	MCB50D3318M-00 MCB50D3318M-01 MCB50D3324M-00 MCB50D3324M-01	
<b>6-DRAWER</b>	MCB51D3630M-00 MCB51D3630M-01		
<b>8-DRAWER</b>		MCB32D3330M-00 MCB32D3330M-01	
<b>10-DRAWER</b>	MCB52D3630M-00 MCB52D3630M-01		

# NEST CART | CONFIGURATIONS

**SINGLE DOOR**



**SINGLE DOOR & DRAWER**



**3-DRAWER & PULLOUT**



**3-DRAWER 18-24"**



**3-DRAWER DOUBLE 30"**



**4-DRAWER 18-24"**



**4-DRAWER DOUBLE 30"**



**5-DRAWER 18-24"**



**6-DRAWER**



**8-DRAWER**



**10-DRAWER**



# EVERHUTCH CAPITAL PROJECTS



# CASE STUDY | NEW CONSTRUCTION







## FLORIDA HOSPITAL

This new 204-bed hospital opened in the Spring of 2024 with two six-story towers designed to enhance patient comfort and care. This facility includes general surgery, orthopedic surgery, urology, imaging, cardia catheterization, emergence care, and labor and delivery.

This project included one hundred and thirty mobile carts, including CORE Carts for the cardiac catheterization labs, code and anesthesia carts for labor and delivery as well as the O.R., CORE Carts and CORE Benches for the Endo/Bronch suites, and CORE Carts and STAT Carts for the I.R. Labs.

This project was delivered over a period of two months and included on-time delivery and installation from our location representatives, Beveridge Medical Associates, Inc.

**PLAN VIEW**  
SCALE: 1/8" = 1'-0"

 <b>STAT CART 16</b> ANES STAT CART - TRUE BLUE 29"W x 26.5"D x 46.7"H (3)3"/(2)6"/(1)9" DRAWERS, ELECT LOCK FULL DRAWER TRAY KITS (PHOTO FOR REFERENCE ONLY) MSC30AM321-05 (EVERHUTCH)	 <b>CORE CART</b> 2-BAY CORE CART - SNOW WHITE 36"W x 27"D x 79"H ELECT KEYPAD LOCK, NO HANDLES (2)2"/(8)3"/(8)8" TRAYS, (10) 18" SHELVES (PHOTO FOR REFERENCE ONLY) MCT201-02-S2A (EVERHUTCH)	 <b>CORE CART 6</b> 3-BAY CORE CART - SNOW WHITE 54"W x 27"D x 79"H (2) ELECT KEYPAD LOCKS, NO HANDLES (1)2"/(3)3"/(1)8" TRAYS, (1)8" BASKET, (1) 18" / (5) 36" SHELVES (PHOTO FOR REFERENCE ONLY) MCT301-02-G3C (EVERHUTCH)
 <b>CORE CART - ANES</b> 1-BAY CORE CART - SNOW WHITE 12"W x 27"D x 79"H KEY LOCK, NO HANDLES (1)MCT603 8" / (3)MCT602 4" / (2)MCT601 2" BASKETS / (2)MCT618 SHELVES (PHOTO FOR REFERENCE ONLY) MCT101-01 (EVERHUTCH)	 <b>CORE CART 5</b> 2-BAY CORE CART - SNOW WHITE 36"W x 27"D x 79"H ELECT KEYPAD LOCK, NO HANDLES ACCESSORIES: TBD (PHOTO FOR REFERENCE ONLY) MCT201-02-C2A (EVERHUTCH)	 <b>CORE CART 3</b> 2-BAY CORE CART - SNOW WHITE 36"W x 27"D x 79"H ELECT LOCK, NO HANDLES (1)4"/(2) 8" TRAYS, (3) CATH RACKS, (6) 36" SHELVES (PHOTO FOR REFERENCE ONLY) MCT201-02-C2C (EVERHUTCH)

8.5x11

**QUANTUM MEDICAL**

208 Autumn Springs Ct.  
Fresno, TN 37067  
www.quantummedical.com

ARCHITECT: -  
ARCH/DATE: -  
REVISIONS:  
09-23-23  
10-04-23  
10-20-23

BAYCARE - SOUTH FLORIDA BAPTIST HOSPITAL  
780 EAST TELECOM PARKWAY, TAMPA, FL 33637  
SURGICAL

ISSUE DATE: 07-27-2023  
QUOTE # QMDD-  
DRAWN BY: JR  
PROJECT MANAGER: -  
SCALE: 1/8" = 1'-0"  
**B2336**

PROPRIETARY AND CONFIDENTIAL. THE INFORMATION CONTAINED IN THIS DRAWING IS THE SOLE PROPERTY OF QUANTUM MEDICAL. ANY REPRODUCTION IN PART OR AS A WHOLE WITHOUT THE WRITTEN PERMISSION OF QUANTUM MEDICAL IS PROHIBITED.

# CASE STUDY | NEW CONSTRUCTION

## FLORIDA HOSPITAL



# CASE STUDY | NEW CONSTRUCTION

## CARDIOVASCULAR SURGERY CENTER

Launched in early 2025, this one-story outpatient cardiovascular center will house three cardiac catheterization labs, 16 preparation and recovery bays, and room for a future buildout of a fourth catheterization lab if needed.

This project included twenty 2-bay CORE Carts with various accessory configurations including pull-out catheter managers, loaded trays and baskets, and general storage with shelves and dividers. Also included were twelve narrow procedure STAT Carts for patient care.

This is one of two current projects for this large health system, including a four-story Orthopedic Health and Performance Center.

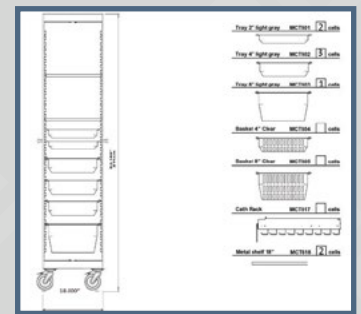
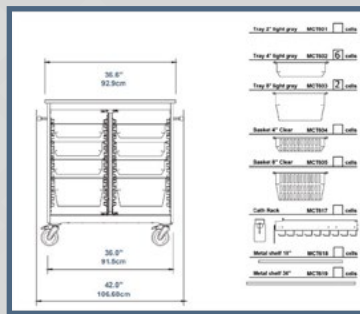
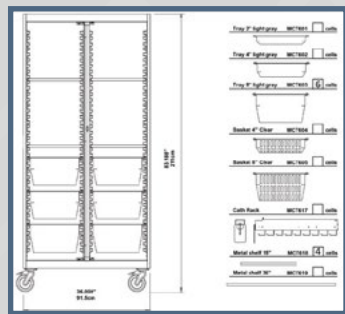
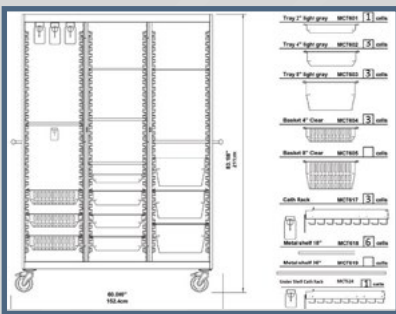

# CASE STUDY | RENOVATION

## UNIVERSITY SCHOOL OF MEDICINE - SURGICAL SIM LAB

Opened in 2024, this multidisciplinary surgical simulation lab provides state-of-the-art platform for hands-on education of surgical trainees in the departments of Otolaryngology, Neurosurgery and Ophthalmology.

This project included several CORE Cabinets including pegboard and trays for instrument storage, custom ceiling enclosures and end scribes to fit the built-in niche for the cabinets.

Part of a larger renovation, Innovative Laboratory Systems met their project's criteria and delivered a highly functional laboratory and equipment system within budget and on-time.

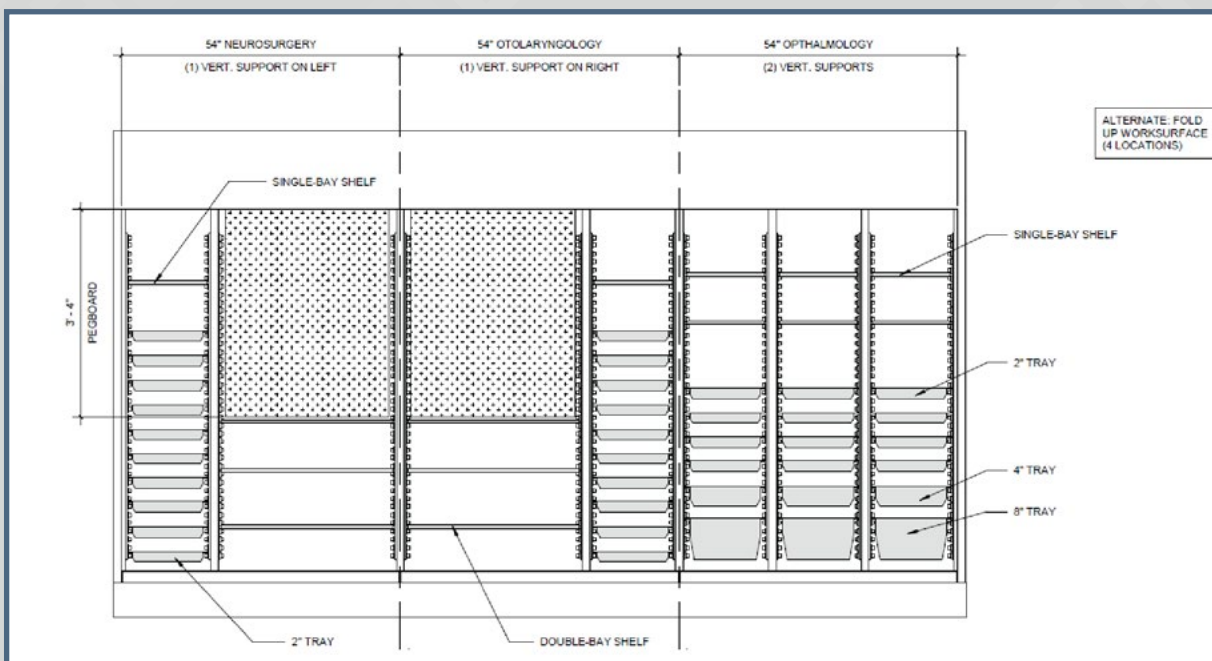

# CASE STUDY | RENOVATION

## PENNSYLVANIA HOSPITAL - HYBRID O.R. RENOVATION

Opening in 2025 for inpatient services, this hospital offers 52 beds, more than 75 exam rooms, and an expanded neonatal unit.

This project included eight custom CORE Cabinets installed into three different niches that included custom locks, ceiling enclosures and end scribes. Located in the corner of the room were four custom base and upper cabinets with matching locks.

The EVERHUTCH team helped facilitate a pre-planning on-site demonstration of CORE Carts, STAT Carts, and CORE Bench, participated in drawing review meetings with the architect and equipment planners, and worked with our distribution partner, CME Corp., to deliver and install the product.



# THE EVERHUTCH CAPITAL PROCESS

## CONSULTATION

- Initial discussion with Architect/Equipment Planners on design intent
- Understand space planning, workflow challenges, and equipment needs
- Focus on identifying appropriate product lines (CORE Cabinets/Carts, Casework, etc.).
- Identify opportunities for on-site product demonstrations

## REFINEMENT

- Collaborate on custom configurations, finishes, and accessories
- EVERHUTCH finalizes drawings
- Quote issued

## MANUFACTURING & WAREHOUSING

- Finalized designs enter production/engineering
- Lead times evaluated and scheduled based on delivery schedule
- Quality control and staging for accurate fulfillment

## DELIVERY & INSTALLATION

- Logistics arranged for on-time delivery to customer site
- On-site support or installer guidance as needed
- Ensure storage solutions integrate seamlessly into workflow





# EVERHUTCH HEALTHCARE DIVISION BY

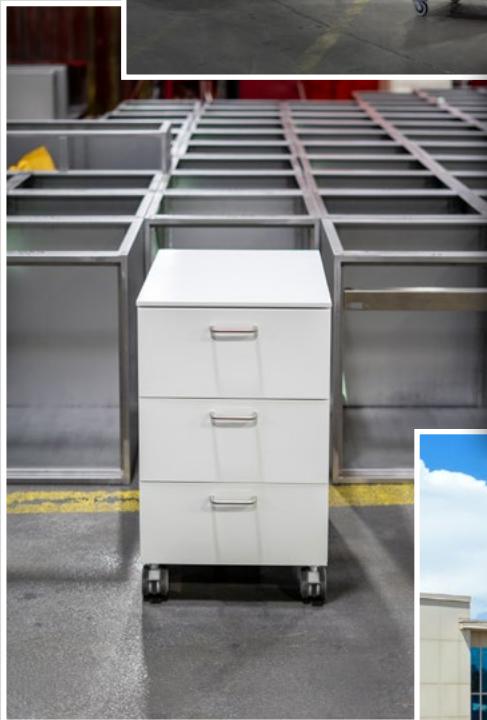

Made in USA



**Founded 1906**

Over 119+ Years of Experience



**Statesville, NC**

USA Manufacturing

**Bangalore, India**

Intl. Manufacturing

**India**

**Singapore**

**Saudi Arabia**

International Sales Offices

**Capacity**  
1,800 Metal Boxes Per Week  
400,000 Sq/ft Project Storage Space

**Largest Laboratory**

362,000 Sq/ft USA Manufacturing Plant and Distribution



**Kewaunee Acquires**



Only place in the world that produces, laboratory grade, wood, metal, technical furniture and resin products from one location

**STATESVILLE, NC**

- **Wood Manufacturing Plant** 139,000 Sq/ft
- **Steel Manufacturing Plant** 159,800 Sq/ft
- **Resin Manufacturing Plant** 64,000 Sq/ft
- **Distribution Space** 365,000 Sq/ft
- **Offices** 43,200 Sq/ft

**Wood**



**Metal**



**Resin**



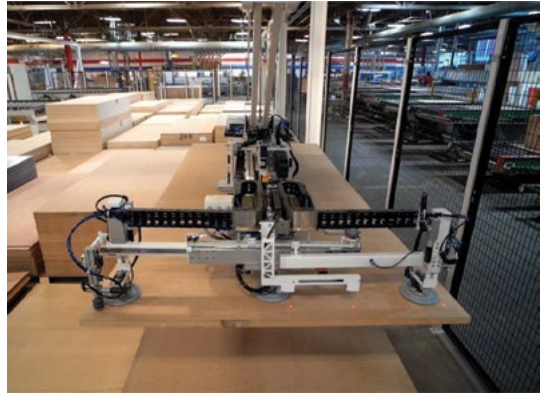

# INDUSTRIES



**PHARMACEUTICALS**



**BIOTECHNOLOGY**



**CHEMICAL**



**PETROLEUM**



**ELECTRONICS**



**HEALTHCARE**



**EDUCATION**



**FOOD & BEVERAGE**

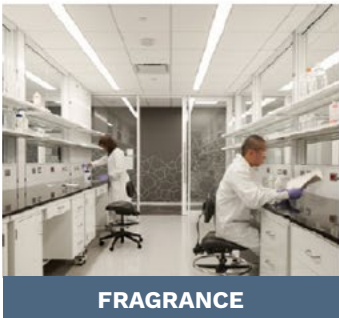

**FRAGRANCE**

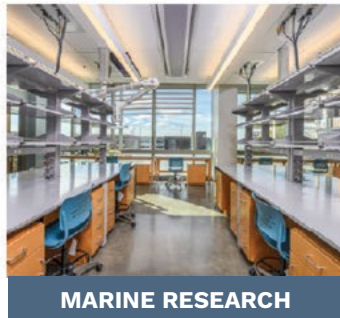

**MARINE RESEARCH**



**DEFENSE**



**FORENSICS**

# PRODUCTS



**STEEL CASEWORK**



**WOOD CASEWORK**



**ADAPTABLE LAB SYSTEMS**

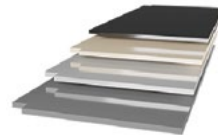

**EPOXY RESIN**



**FUME HOODS**

# STAINLESS PROJECTS



KEWAUNEE<sup>®</sup>  
EST 1906

# LABORATORY PROJECTS



# LABORATORY PROJECTS



# LABORATORY PROJECTS



# LABORATORY PROJECTS





# EVERHUTCH

**EVERHUTCH.com**

**INFO@EVERHUTCH.com**



**2700 W FRONT STREET, STATESVILLE, NC 28677**



**EVERHUTCH**

2700 W FRONT STREET, STATESVILLE, NC 28677  
EVERHUTCH.com