



# STAT CART

**MSC30AM**

**STANDARD 29"W**

## PRODUCT DESCRIPTION

This procedure cart was specifically designed for patients and caregivers in mind. Defining features promote infection control, adaptability and durability. **STATCART** standard sizes and options in drawers and trays were made to be compatible with existing procedure carts on the market today. This compatibility creates conformity and allows hospitals to easily upgrade their cart without the need to update protocols. **STATCART** is quickly adaptable to meet the demands of different departments with Paladin Healthcare efficient Equipment Management Rail System. Due to the adaptability of its components, this system allows customers to find the optimal solution to answer specific clinical needs. Available with multiple lock options including a key lock, electronic keypad and electronic keypad with proximity card reader. The locking system can also be set up to offer dual credential unlocking. The cart is easily maneuvered around on plate-mounted swivel and locking casters.

This high quality storage system is manufactured and sourced in the US and can withstand any demanding healthcare environment.

## KEY BENEFITS

### Maneuvers Easily

- 5" locking swivel casters
- 5" tracking caster

### Supports Thorough Cleaning

- Integrated seams
- Smooth exposed surfaces
- Chemical-resistant powder coat
- Corner posts with less channels to clean
- Removable draws & trays
- Scratch resistant Acrylic ABS work surface with drip edge & smooth corners for easy cleaning

### Security

- Key lock
- Electronic keypad
- Prox card reader (High & Low frequencies)
- Self-closing drawers

### Adaptable To Your Workflow

- Configurable drawers of increments of 3", 6" and 9"
- Full-extension, soft closing drawers
- Interchangeable components with Paladin Healthcare Equipment Management Rail System

### 8 STATCART Configurations

- Available in four heights in standard and narrow widths



STATESVILLE, NC



**EVERHUTCH**

# STAT CART

**MSC30AM**

**STANDARD 29"W**

## SPECIFICATIONS

### Caster

- 5" Swivel Locking Casters:  
3 Total Lock & 1 Direction Lock
- 5" Caster Overall

### Material

- Shell 18-Gauge Steel
- Drawers 20-Gauge Steel

### Certifications

- Conforms to UL 60601

### Finish

- ABC Powder Coat

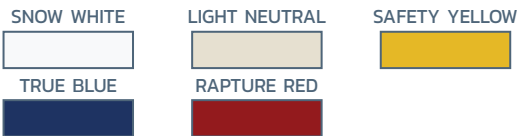

### Drawer handles

- Brushed Stainless Steel

### Warranty

- Limited Life Time Warranty

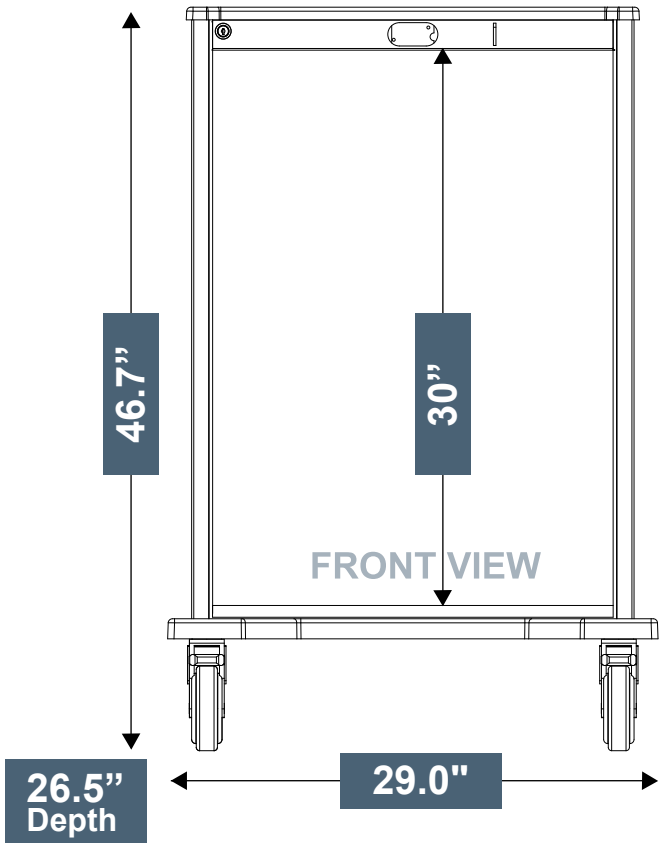

## DRAW CONFIGURATIONS

MSC30AM810

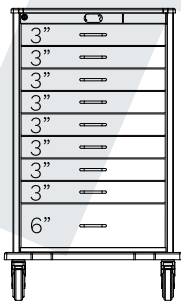

MSC30AM430

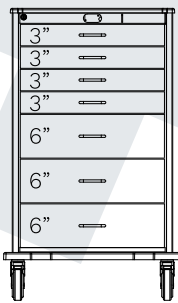

MSC30AM240

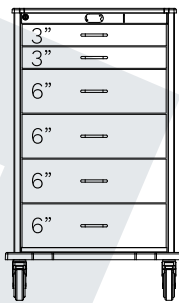

MSC30AM050

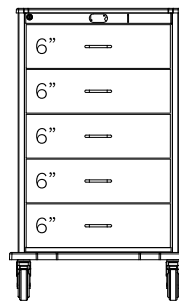

MSC30AM511

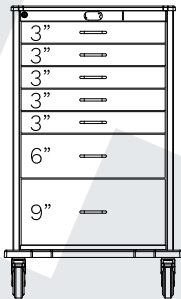

MSC30AM212

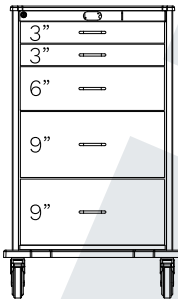

MSC30AM131

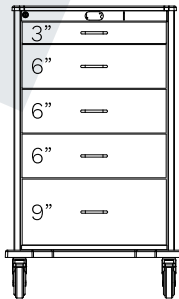

MSC30AM321

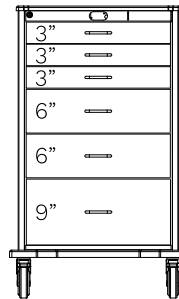

## LOCK OPTIONS -XX

- 01 Manual Lock
- 05 Electronic Lock
- 06 Keyless Electronic Keypad Proximity Card HID access
- 07 Keyless Electronic Keypad I-Class HID Access High Freq
- 08 Drawer Lock
- 09 Gang Lock

KEWAUNEE®

**EVERHUTCH**

2700 W Front St, Statesville, NC 28677

Sales@EVERHUTCH.com